

IF THE TOTAL WATTS OF ELECTRICAL APPLIANCES EXCEEDS THE OUTPUT CAPACITY OF INVERTER. OR AFTER OPERATING FOR A PERIOD OF TIME. IF THE TEMPERATURE OF THE INVERTER REACHES 60 , THE INVERTER SHALL BE REDUCED AC OUTPUT BY THE PROTECTION CIRCUIT.

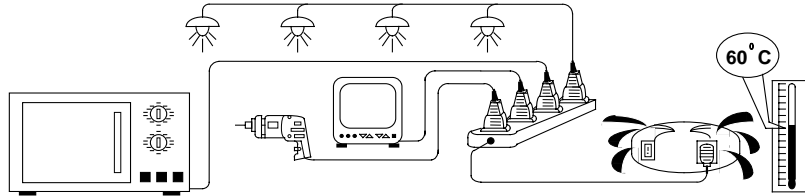

FULL AUTOMATIC DC-AC 2500W INVERTER & BATTERY CHARGER

DC12V or 24V to AC220V~240V Instruction Manual

Please read user manual before use.

CAUTION

- * ALWAYS PLACE THE INVERTER IN AN ENVIRONMENT WHICH IS :
- (A) WELL VENTILATED
 - (B) NOT EXPOSED TO DIRECT SUNLIGHT OR HEAT SOURCE
 - (C) OUT OF REACH FROM CHILDREN
 - (D) AWAY FROM WATER/MOISTURE, OIL OR GREASE
 - (E) AWAY FROM ANY FLAMMABLE SUBSTANCE

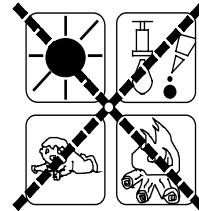

WARNING FLUORESCENT LAMP
DO NOT USE THIS DEVICE WITH FLUORESCENT LAMPS.

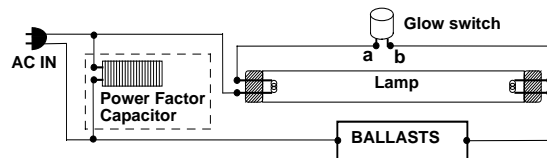

USEFUL APPLICATIONS

RUN NOTEBOOK COMPUTERS, RADIOS, TVS, VCERS,
LAMPS, FANS, FAX, DRILL, ETC.

SPECIFICATION

INPUT VOLTAGE RANGE : DC 10~15V (12V) // DC 20~30V (24V)

INPUT FULL LOAD CURRENT : 230A (12V) // 115A (24V)

STANDBY INPUT CURRENT : <0.7A (12V) // <0.6A (24V)

OUTPUT VOLTAGE (AC) : 220V~240V

OUTPUT WAVEFORM : MODIFY SINE WAVE

OUTPUT FREQUENCY : 50Hz

CONTINUE OUTPUT POWER : 2500W

PEAK OUTPUT POWER : 5000W

EFFICIENCY : 85~90%

BATTERY LOW PRE-ALARM : $10.5 \pm 0.5V$ (12V) // $21 \pm 0.5V$ (24V)

BATTERY LOW SHUTDOWN : $10 \pm 0.5V$ (12V) // $20 \pm 0.5V$ (24V)

THERMAL PROTECT : 60 ± 5 (MICROCONTROLLER)

AUTO-OPERATION FAN (TEMPERATURE OR LOAD)

OVER LOAD PROTECT : YES (MICROCONTROLLER)

OUTPUT SHORT PROTECT : YES (MICROCONTROLLER)

BATTERY EX. 12V / 24V PROTECT : YES (MICROCONTROLLER)

BATTERY POLARITY PROTECT : YES (BY FUSE)

FUSE : 20A*16PCS (12V) // 10A*16PCS (24V)

TRANSFER TIME : 16m SEC

CHARGER CURRENT : MAX. 10A (12V) // 5A (24V)

DIMENTION (L*W*H) mm : 420*169*152

WEIGHT : 7.8Kg

BATTERY LED DARK/LIGHT INDICATIVE CHART.

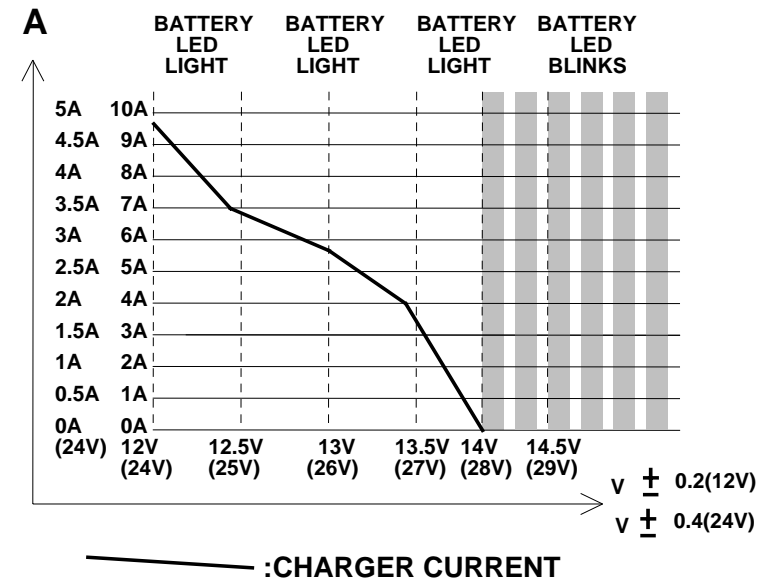

INDICATING SIGN

NORMAL LIGHTED LED : POWER SWITCH " ON ", INVERTER STANDBY

NORMAL UNLIGHTED LED : POWER SWITCH " OFF "

CHARGER LIGHTED LED : BATTERY CHARGING

CHARGER LED BLINKS : FULL BATTERY

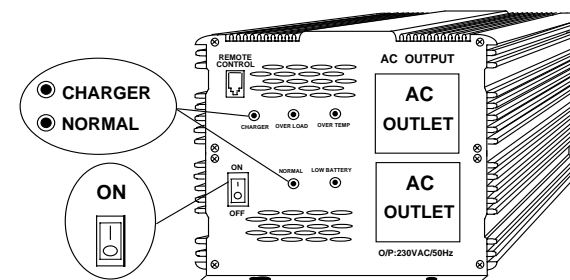

CHARGER

CONNECT AC INPUT POWER CORD TO HOME MAIN SOCKET THEN USE RED BATTERY CORD TO CONNECT (+) OF DC BATTERY TO (+) SINDING POST.AND USE BLACK BATTERY CORD TO CONNECT (-) BATTERY TO (-) SINDING POST.

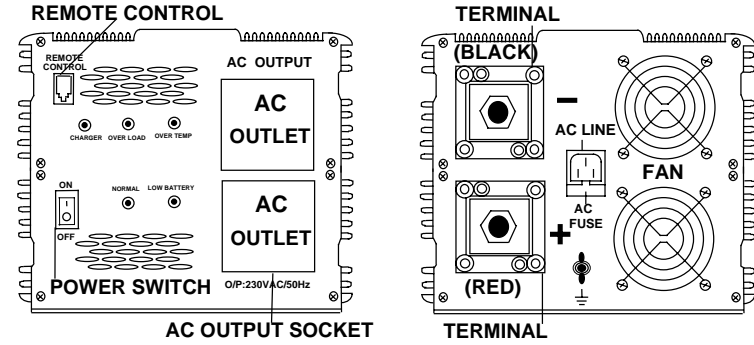
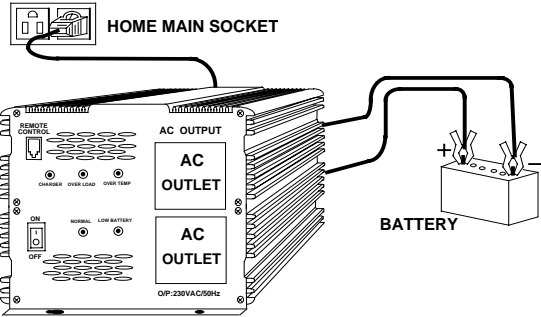

CAUTION : DO NOT REVERSE INPUT. USE RED BATTERY CORD TO CONNECT (+) OF A DC BATTERY TO (+) TERMINAL. AND THEN, USE BLACK BATTERY CORD TO CONNECT (-) BATTERY TO (-) TERMINAL.

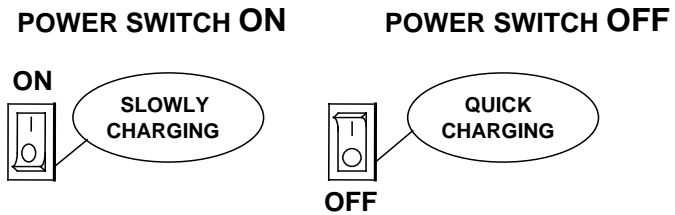
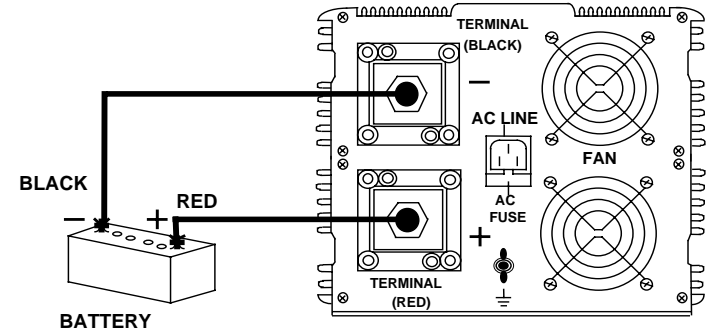

WARNING

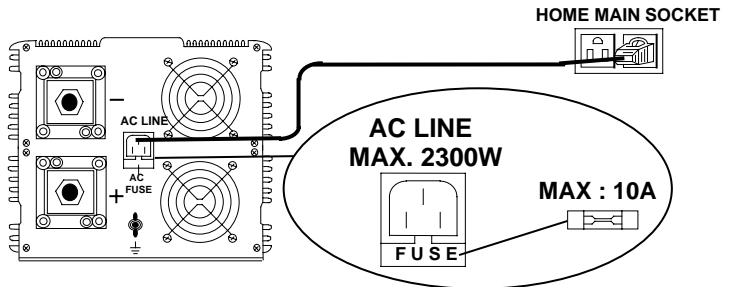

WARNING SIGNAL

LOW BATTERY PRE-ALARM BI-----BI-----BI
 OVER HEATING PRE-ALARM BI---BI---BI---BI---BI
 OVER LOAD PRE-ALARM BI-BI-BI-BI-BI-BI-BI

USE INVERTER

STEP1: SET THE POWER SWITCH AT THE OFF

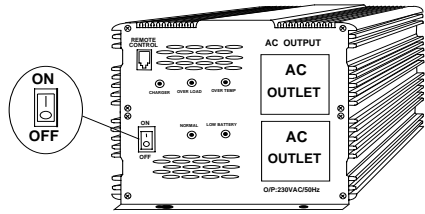

STEP2:
WHEN CONNECTED TO ANY APPLIANCE, BE SURE TO TURN ON INVERTER FIRST. AND THEN, TURN ON THE POWER SWITCH OF THE APPLIANCE.

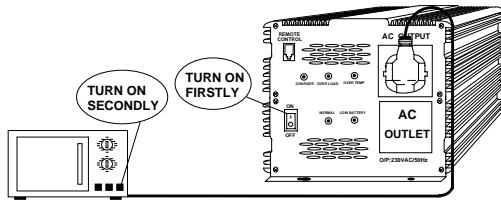

DO NOT USE THE INVERTER EXCEED ITS MAXIMUM OUTPUT POWER, WHEN CONNECTED TO ANY APPLIANCE. MAKE SURE THE TOTAL STARTING POWER CAPACITY DOES NOT EXCEED THE MAXIMUM OUTPUT POWER OF THE INVERTER.

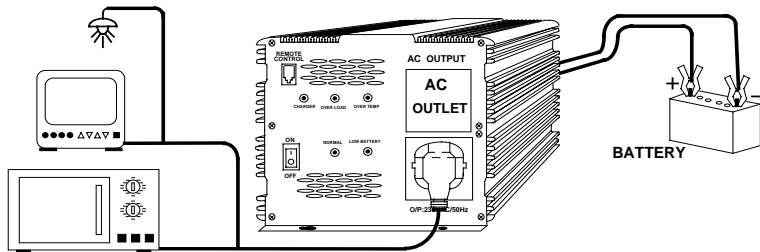

AS UPS

IF YOU WANT TO USE THIS UNIT AS U.P.S. FUNCTION , TURN ON THE SWITCH OF THE INVERTER AT FIXED POSITON FIRSTLY. WHEN THE BLACK OUT OCCURS IN THE MEANTIME, THE INVERTER WILL DIVERT AUTOMATICALLY FROM HOME ELECTRICITY INTO THE BATTERY TO SUPPLY THE POWER FOR APPARATUS USE CONTINUALLY.

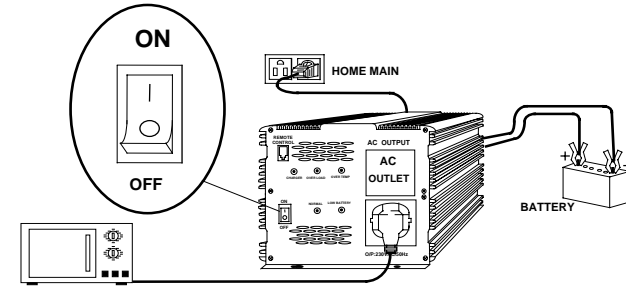

CHASSIS EARTH

CHASSIS EARTH:

THE CHASSIS EARTH LUG SHOULD BE CONNECTED TO AN EARTH POINT, WHICH WILL VARY DEPENDING ON WHEN THE POWER INVERTER IS INSTALLED. IN A VEHICLE, CONNECT THE CHASSIS GROUND LUG TO THE CHASSIS OF THE VEHICLE. IN A BOAT, CONNECT TO THE BOAT'S GROUND SYSTEM. IN A FIXED LOCATION, CONNECT TO EARTH.

