

DC TO AC POWER INVERTER 5000W

DC12V or 24V to AC220V~240V Instruction Manual

Please read user manual before use.

USEFUL APPLICATIONS

RUN NOTEBOOK COMPUTERS, RADIOS, TVS, VCRS, LAMPS, FANS, FAX, DRILL, MICROWAVE OVEN, OVEN,.....ETC.

SPECIFICATION

INPUT VOLTAGE RANGE : DC 10~15V (12V) // DC 20~30V (24V)

INPUT FULL LOAD CURRENT : 500A (12V) // 250A (24V)

STANDBY INPUT CURRENT : <0.7A (12V) // <0.6A (24V)

OUTPUT VOLTAGE (AC) : 220V~240V

OUTPUT WAVEFORM : MODIFY SINE WAVE

OUTPUT FREQUENCY : 50Hz

CONTINUE OUTPUT POWER : 5000W

PEAK OUTPUT POWER : 10000W

EFFICIENCY : 85% ~ 90%

BATTERY LOW PRE-ALARM : $10.5 \pm 0.5V$ (12V) // $21 \pm 0.5V$ (24V)

BATTERY LOW SHUTDOWN : $10 \pm 0.5V$ (12V) // $20 \pm 0.5V$ (24V)

THERMAL PROTECT : 60 ± 5 (MICROCONTROLLER)

OVERLOAD PROTECT : YES (MICROCONTROLLER)

OUTPUT SHORT PROTECT : YES (MICROCONTROLLER)

BATTERY EX. 12V / 24V PROTECT : YES (MICROCONTROLLER)

BATTERY POLARITY PROTECT : YES (BY FUSE)

FUSE : 30A*24PC (12V) // 20A*24P (24V)

DIMENSION (L*W*H) mm : 500*169*152

WEIGHT : 10.8 KG

TROUBLESHOOTING

IF THE INVERTER DOES NOT APPEAR TO BE FUNCTIONING PROPERLY, THERE ARE SEVERAL REASONS WHY THE INVERTER MAY NOT BE RESPONDING.

1) POOR CONTACT

*CLEAN CONTACT PARTS THOROUGHLY

2) RECEPTACLE HAS NO POWER

*CHECK CAR FUSE, REPLACE DAMAGED FUSE

*CHECK RECEPTACLE WIRING. REPAIR IF NECESSARY

3) FUSE IS BLOWN

*THE FUSE IS LOCATED INSIDE THE P.C.B. REPLACE FUSE WITH A FUSE OF EQUIVALENT VALUE

4) OVERLOAD CAUSED AC OUTPUT REDUCE

*REDUCE THE WATTAGE OF YOUR LOAD TO LOWER THAN 5000 WATTS

5) THERMAL CAUSED AC OUTPUT REDUCE

*UNDER HEAVY LOADS FOR EXTENDED PERIODS OF TIME. THE AC INVERTER WILL REDUCE OUTPUT TO PREVENT DAMAGE TO EXCESS HEAT. IF THIS HAPPENS, PLEASE PROCEED AS BELOW :

(A) SWITCH OFF THE POWER SWITCH OF THIS INVERTER

(B) DECREASE LOAD OF THIS MACHINE I. E. DISCONNECT SOME OF THE APPLIANCES OR WAIT UNTIL THIS INVERTER BECOME COOL.

(C) SWITCH ON THE POWER SWITCH OFF THIS INVERTER.

6) LOW-BATTERY SHUTDOWN

*RECHARGE YOUR BATTERY AND RESUME OPERATION.

CAUTION

ALWAYS PLACE THE INVERTER IN AN ENVIRONMENT WHICH IS:

(A) WELL VENTILATED

(B) NOT EXPOSED TO DIRECT SUNLIGHT OR HEAT SOURCE

(C) OUT OF REACH FROM CHILDREN

(D) AWAY FROM WATER/MOISTURE, OIL OR GREASE

(E) AWAY FROM ANY FLAMMABLE SUBSTANCE

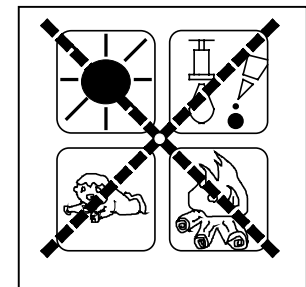

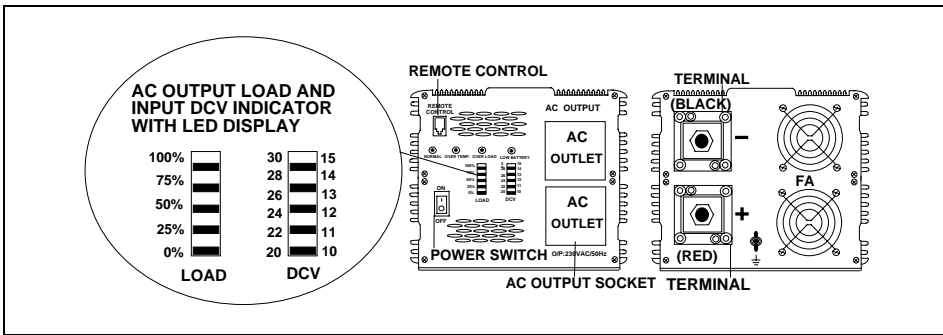

CHASSIS EARTH:
 THE CHASSIS EARTH LUG SHOULD BE CONNECTED TO AN EARTH POINT, WHICH WILL VARY DEPENDING ON WHERE THE POWER INVERTER IS INSTALLED. IN A VEHICLE, CONNECT THE CHASSIS GROUND LUG TO THE CHASSIS OF THE VEHICLE. IN A BOAT, CONNECT TO THE BOAT'S GROUND SYSTEM. IN A FIXED LOCATION, CONNECT TO EARTH.

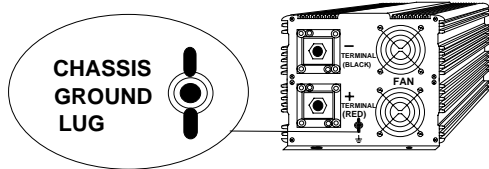

CAUTION : DO NOT REVERSE INPUT. USE RED BATTERY CORD TO CONNECT (+) OF A DC BATTERY TO (+) TERMINAL. AND THEN, USE BLACK BATTERY CORD TO CONNECT (-) BATTERY TO (-) TERMINAL.

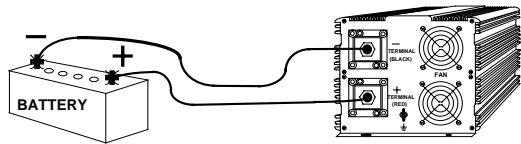

IF THE TOTAL WATTS OF ELECTRICAL APPLIANCES EXCEEDS THE OUTPUT CAPACITY OF INVERTER. OR AFTER OPERATING FOR A PERIOD OF TIME. IF THE TEMPERATURE OF THE INVERTER REACHES 60 DEG C, THE INVERTER SHALL BE REDUCED AC OUTPUT BY THE PROTECTION CIRCUIT.

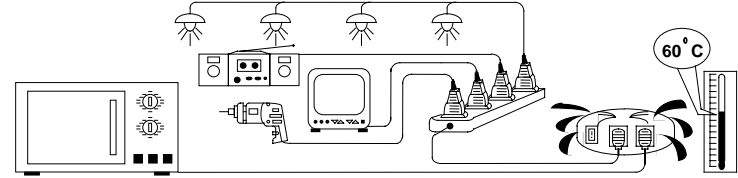

WHEN CONNECTED TO ANY APPLIANCE, BE SURE TO TURN ON INVERTER FIRST. AND THEN, TURN ON THE POWER SWITCH OF THE APPLIANCE.

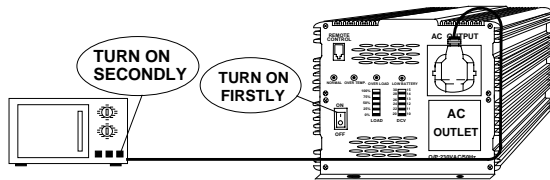

WARNING SIGNAL

LOW BATTERY PRE-ALARM BI-----BI-----BI
 OVER HEATING PRE-ALARM BI---BI---BI---BI---BI
 OVER LOAD PRE-ALARM BI-BI-BI-BI-BI-BI-BI

REMOTE CONTROL OPERATION :
 WHEN CONNECTED TO ANY APPLIANCE, BE SURE TO TURN ON INVERTER FIRST. AND THEN, CONNECT WITH THE REMOTE CONTROL WELL AND TURN ON THE SWITCH OF REMOTE CONTROL.

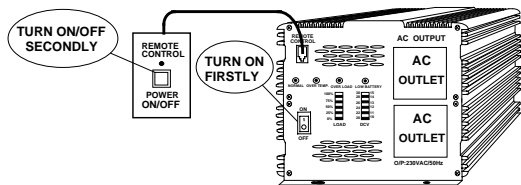

WARNING FLUORESCENT LAMP
 DO NOT USE THIS DEVICE WITH FLUORESCENT LAMPS.

